

# DPGUARD®



**Filtration manager for automatic calculation of corrected differential pressure measurement in refuelling applications**

## 1 Synchronisation of sensor signals

DPGUARD's essential functionality relies on incoming sensor signals from dp transmitter and flow meter to mathematically correlate and calculate corrected differential pressure values. Mathematical correlation is performed in millisecond time frame. Therefore precision of readout highly depends on synchronization of incoming sensor signals. In most cases signals of different physical sources do not have the same behavior. They tend to completely differ with regard to their time response. But if correlated signals are not properly synchronized – very bad results for corrected dp during changes in velocity are the result.

The common way to synchronize different incoming signals is the use of delay and attenuation times. But how effective could this be done without the knowledge about signal behavior.

Realizing the difficulty of synchronization forced us to implement the below described tool to analyze and synchronize incoming sensor signals.

DPGUARD software does have a special synchronization feature where you could do a signal analysis combined with a proposal of recommended numbers for delay and attenuation time for both sensor signals (red curve represents flow signal, blue chart represents dp transmitter signal, Td / Ta are proposed numbers for delay and attenuation times to be used in setup for each sensor signal):

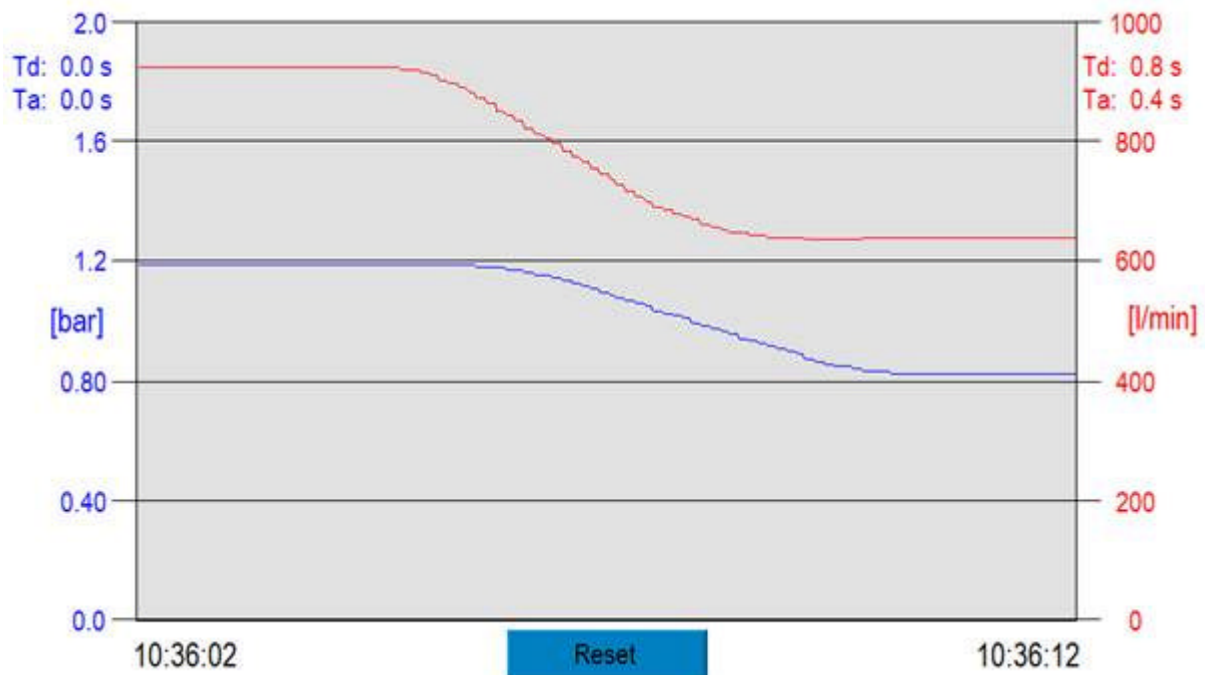

Following procedure describes on how to synchronize sensor signals together with fundamental information according physical cabling of sensors.

1.1 Installation and initialisation of sensor signals

DPGUARD need to have information about flow and differential pressure across installed filter elements. This normally comes from electronic devices like differential pressure transmitters and flow meters. Both signals should be connected to DPGUARD and must be configured during installation process.

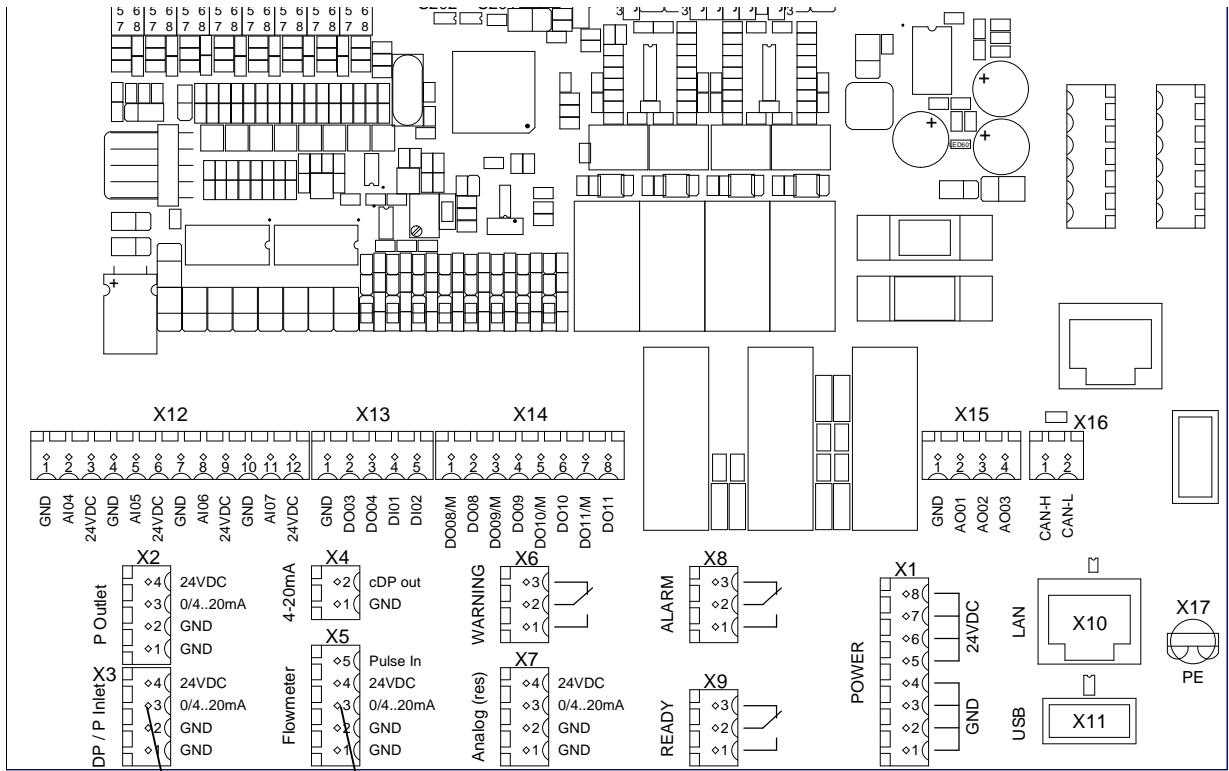

KSK73023\_V01\_LP83800.pcb

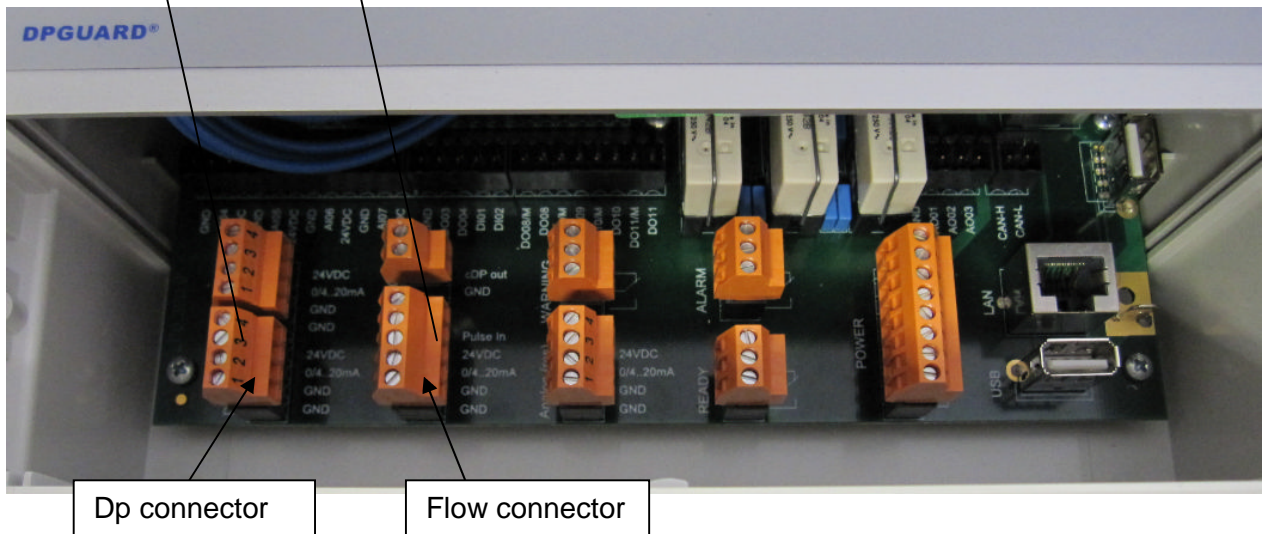

**Picture: Terminal Area - Look into DPGUARD**

## 1.2 Electrical setup

### 1.2.1 Pressure sensor

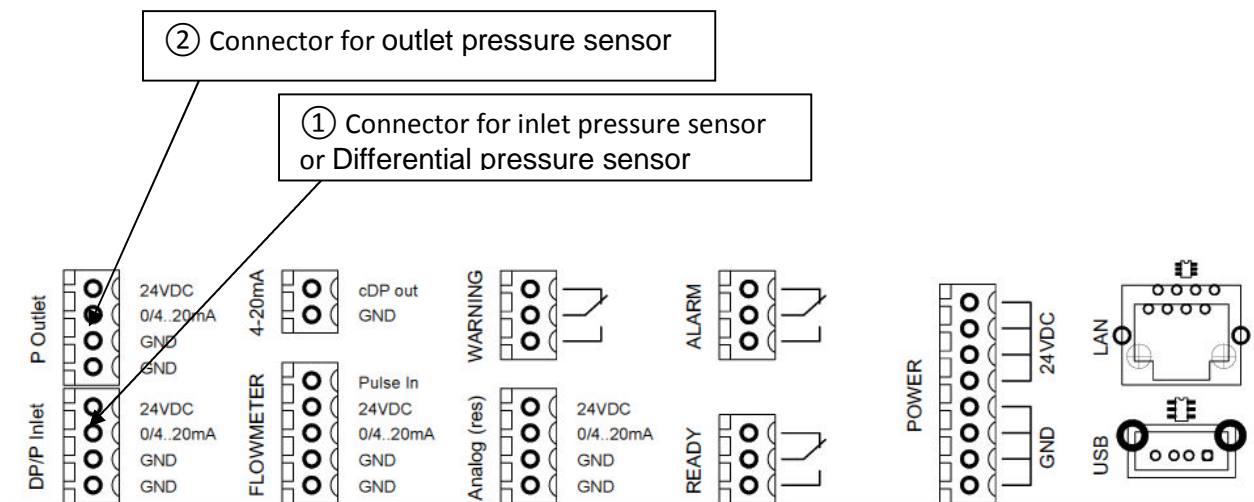

Picture of connection board pressor sensor connectors

Elaboration of terms on pressure sensor screen:

①	Connector for differential pressure sensor or single inlet pressure sensor.
②	Connector for single outlet pressure sensor (use only if ① is single inlet pressure sensor)

#### 1.2.1.1 Cabling - Connection to differential pressure transmitter

Please refer to original manual delivered together with differential pressure transmitter

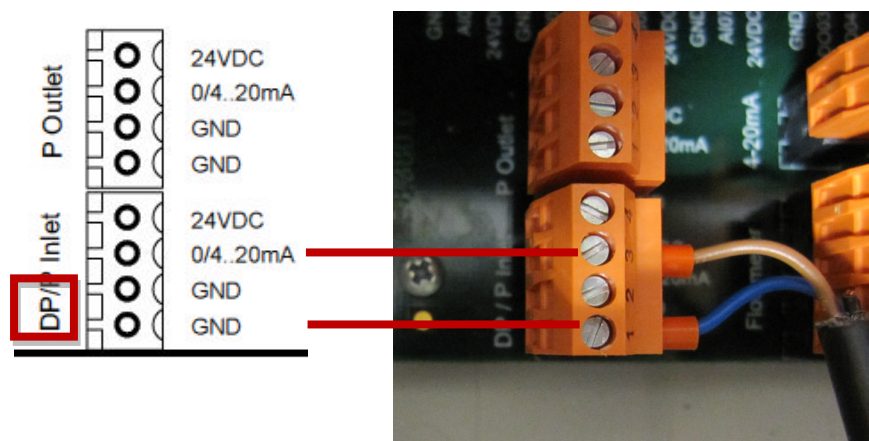

Example shows the installation of one differential pressure transmitter DP.  
Please make sure to use a barrier if required for hazardous area zone installation!

### 1.2.2 Flow meter

Connection of flow signal coming from flow meter

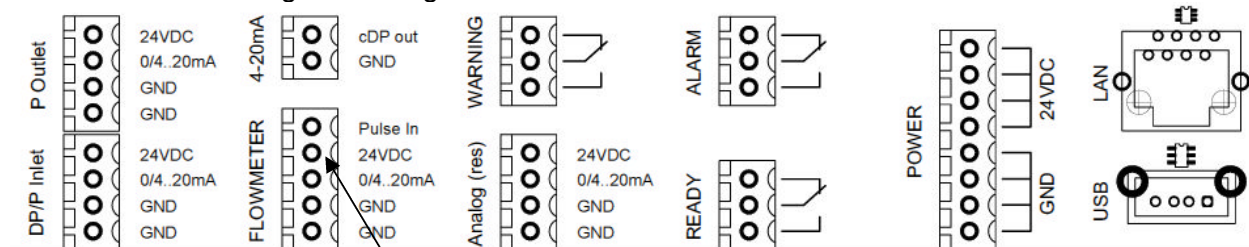

③ Flow sensor for current or pulsed signal input

#### 1.2.2.1 Cabling - Connection to flow sensor

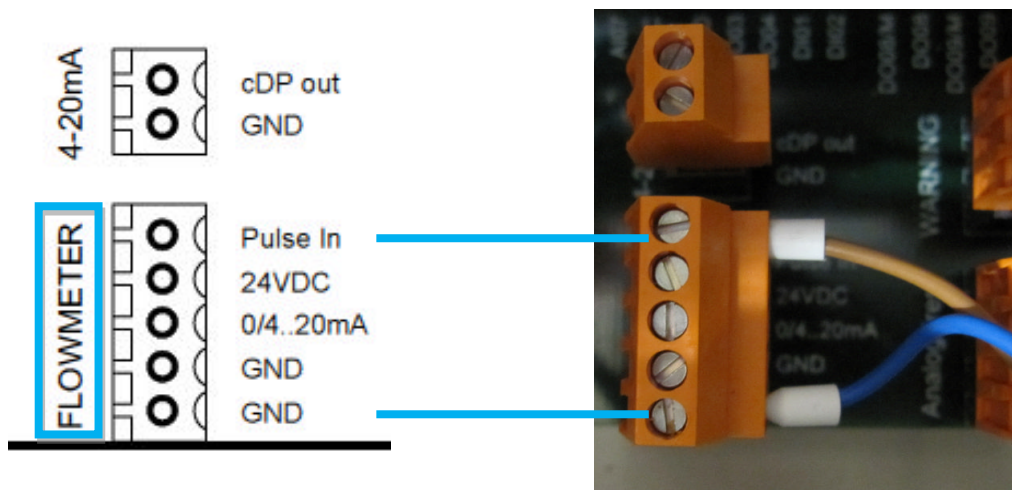

Example shows the cabling for a pulsed flow signal coming from the flow meter. In case of current signals for flow transmitters please use the 0/4...20mA connector instead of Pulse in.

Please make sure to use a barrier if required for hazardous area zone installation!

### 1.3 Settings - Setup in DPGUARD software

Step by step explanation on how to set up sensor signals in DPGUARD setup menu

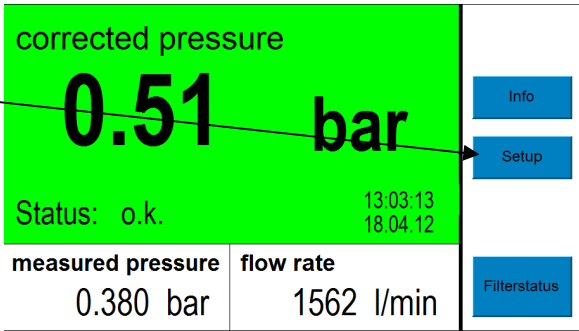
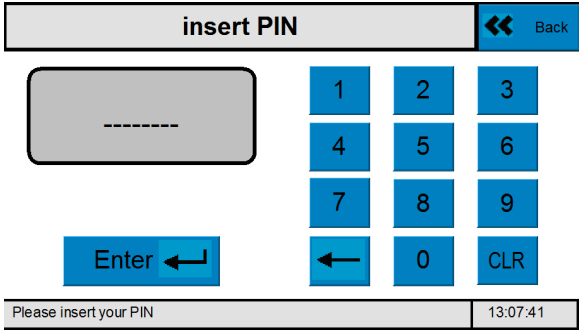
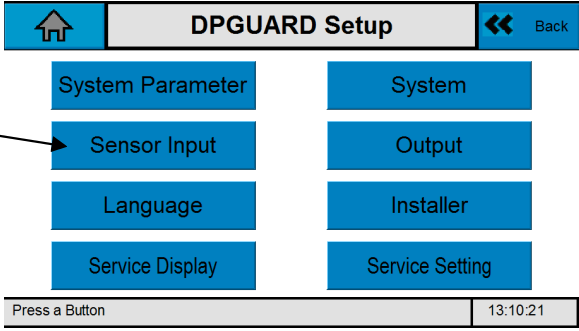
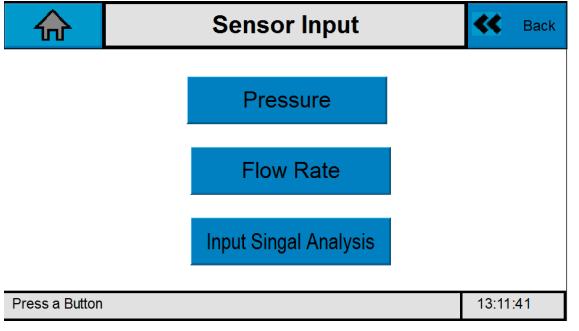
<p>Press <b>setup</b> button on main screen</p>	
<p>Type in</p> <ul style="list-style-type: none"> <li>- Administrator password "12345678" (to only set up sensor settings) or SERVICE password "3748273" to also go into signal analysis</li> <li>- press <b>Enter</b> button</li> </ul> <p>Example shows procedure under SERVICE password level</p>	
<p>You reach DPGUARD setup menu level Press <b>Sensor Input</b> button to enter sensor submenu</p>	
<p>Now you are in Sensor Input submenu to define settings for pressure and flow rate sensor. First action: Pressure Sensor Press <b>Pressure</b> button to enter Pressure Sensor submenu</p>	

You need to adjust:

- 1) Mode of Sensor:
  - 1xDP: differential pressure or
  - 2xP two pressure sensors (one for inlet and one for outlet pressure)
- 2) Signal quality:
  - 0 to 20 mA or
  - 4 to 20 mA
- 3) Max. pressure range of pressure sensor (refer to calibration protocol)
- 4) Delay / average of pressure sensor

Please refer to operation manual for sub item 1 to 3

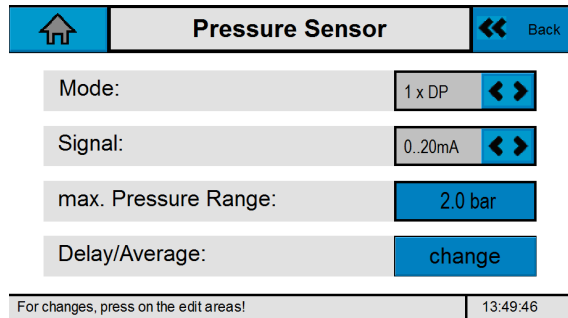

Delay / average of pressure sensor should be adjusted to synchronize the sensor signal together with another sensor signal that should be in time with pressure sensor signal.

Please do setup for both sensors (dp and flow sensor) in front of any setup for delay or attenuation!

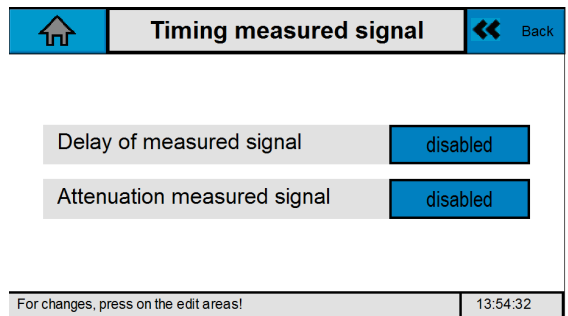

Go back to address flow sensor. Press **Flow Rate** to address Flow Rate Sensor.

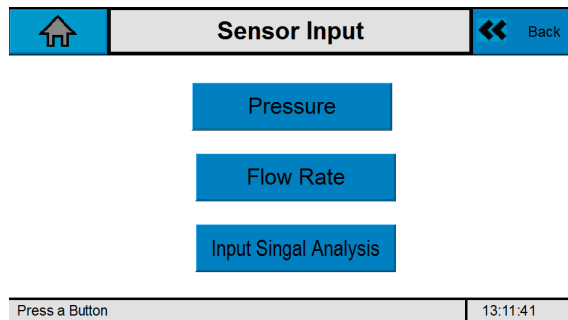

You need to address:

- 1) Mode of Signal
    - 0 to 20 mA or
    - 4 to 20 mA or
    - Pulse signal
  - 2) Max flow rate (only important if current sensor is installed)
  - 3) Delay / average of flow rate sensor
- Please refer to operating manual for sub items 1 and 2

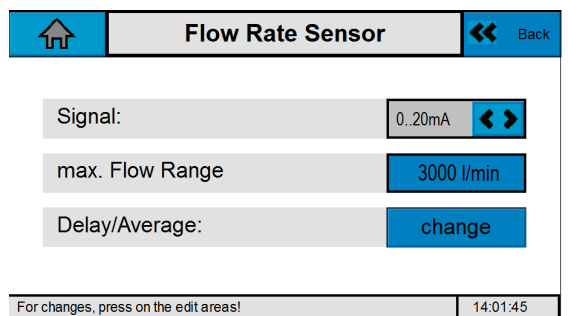

Go back to sensor Input submenu to address signal analysis

Input Signal Analysis:  
Go back to Sensor Input Submenu and press **Input Signal Analysis** button

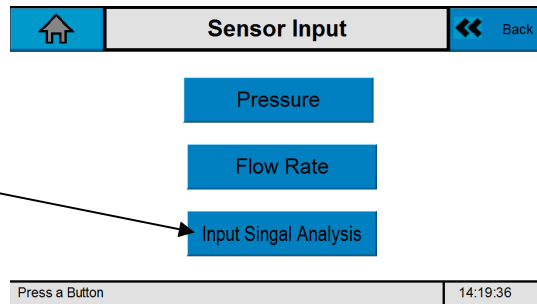

Now you are in Input Signal submenu where you need to do settings for signal analysis. You will be asked to setup:

- Start/Trigger Flow: - do not change the value
- Time Interval: You can go down to 10 sec to better visualize the analysis effects
- Display max flow: dependent on what you can reach during test
- Display max. pressure: dependent on element behaviour during test

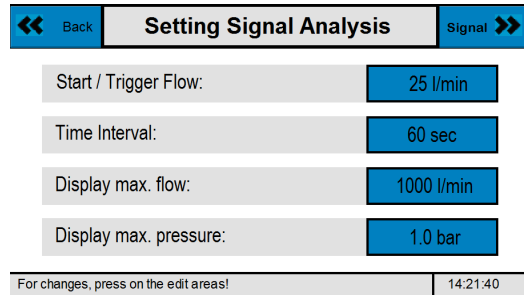

Recommended settings for a vessel of 2500 Liter/min rated flow and new Monitor elements (see settings)  
Change settings by pressing each button to be changed.  
If changes are proceeded, press **Signal>>** button to enter chart for signal analysis

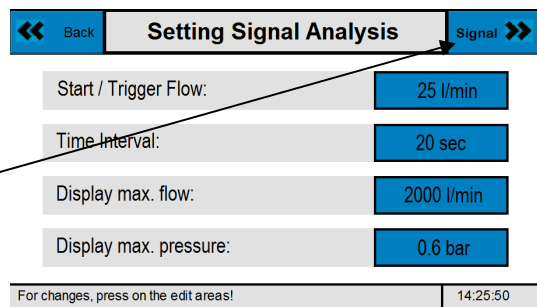

Now you are in signal analysis mode.  
Press **RESET** button to reset numbers  
You will find:

**Red chart curve** representing flow rate signal  
**Blue chart curve** representing dp signal  
Blue and red colour values for Td and TA,  
representing proposed values for Delay (d)  
and attenuation (a)  
Numbers on axis are with regard to settings  
in setting signal Analysis submenu.





### How to proceed a signal analysis:

You need to run your system on a test rig or you can either use the function under real operating conditions.

- 1) Press **Reset** in front of any flow change
- 2) Counter will start and changes in dp and flow will be displayed.
- 3) Signal analysis stops fully automated when counter pre-set time is over (20 sec in example above)
- 4) Proposed settings for delay and attenuation are displayed beside axis of dp and flow

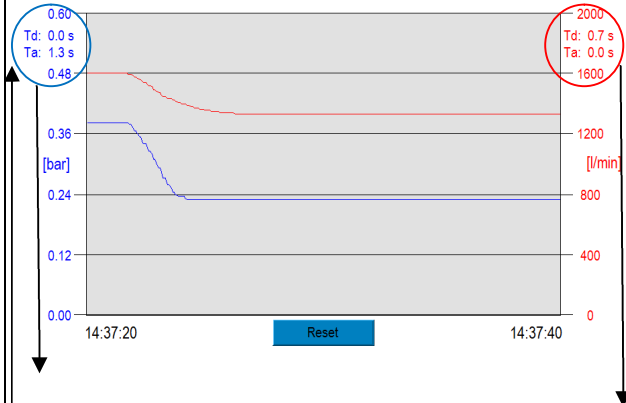

### Result:

Td = 0,0 Sec	Td = 0,7 Sec
Ta = 1,3 Sec	Ta = 0,0 Sec

Write down numbers and go back into Sensor Input submenu to set up delay and attenuation values  
You can leave signal analysis screen by pressing somewhere onto the active field

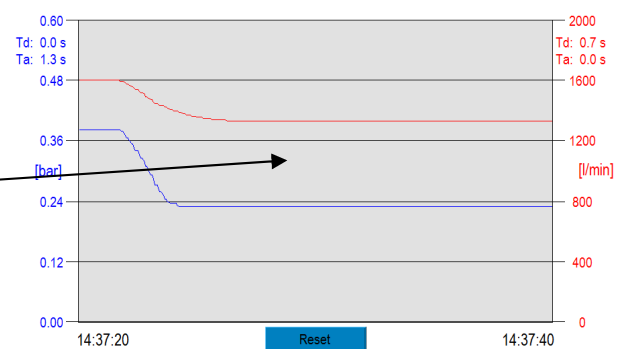

### Adjust proposed numbers for delay and attenuation for pressure and flow rate sensor

**Pressure sensor**

⏪ **Timing measured signal** ⏩ Back

Delay of measured signal disabled

Attenuation measured signal 1.3 sec

For changes, press on the edit areas! 14:44:49

**Flow rate sensor**

⏪ **flow meter timing** ⏩ Back

Delay of measured signal 0.7 sec

Attenuation measured signal disabled

For changes, press on the edit areas! 14:46:36

Now you are ready with the setup of signal synchronisation.

If you want to run signal analysis again – press **Reset** button to reset counter

In case of already existing pre-set's for delay and attenuation – please add proposed numbers and go back to check for plausibility (e.g. run an additional signal analysis test).

<b>Version 0</b>		<b>Signal synchronization</b> <b>DPGUARD®</b> <b>English</b>	
Page: 10	of: 10		